

# Operating and Programming Instructions for the Control Units for Vibratory Drives

## Type ESR 2000

## 1.1 Performance Characteristics

This compact control unit has been designed to operate a bowl or linear feeder.

The unit has the following performance characteristics:

- a power regulator for vibratory drive unit with variable output frequency, load current max. 6A
- two sensor amplifiers with independently adjustable time levels (on/off).
- 24V DC remote control input.
- two relay outputs and two optocouplers for status messages and further links.
- a membrane keyboard for setting and editing the operating values (parameters) in the setting menus.
- plug connections for
  - bowl or linear feeder
  - sensors
  - communication
- double-pole mains power switch

## 1.2 EC Conformity

The control unit complies with the following regulations:

**EC - EMC Directive 89/336/EEC**  
**EC Low voltage equipment directive (73/23/EEC)**

Applied harmonised standards:

**EN 60204 T.1**  
**EC - EMC Directive EN 50081-1**  
**EN 50011, Limit value class B**  
**EC - EMC Directive EN 50082**

Applied national technical specifications:

**BGV - A2**

## 1.3 Technical Data

Mains voltage:	230 Volt AC, 50/60 Hz, +20 / -15% 110 Volt AC, 50/60 Hz, +10 / -10%
Output voltage:	0 ... 208 V <sub>eff</sub> / 230 VAC ; 0 ... 98V <sub>eff</sub> / 110VAC
Load current channel 1:	6 A <sub>eff</sub>
Minimum load current:	80 mA
Output frequency	30 to 140 Hertz
Internal fuse:	F1 = 10A
Soft start time, soft stop time	0 ... 5 sec., can be selected separately
External setpoint:	0 ... 10V DC
Sensor inputs:	2
Remote control input:	24V DC (10-24 VDC)
Sensor power supply:	24V DC, max. 60 mA (per sensor input)
Sensor delay ON:	0 ... 60 sec.
Sensor delay OFF:	0 ... 60 sec.
Outputs:	2 relays / 2 potential-free change-over contacts
Status output (optocoupler):	max. 30V DC 10mA, 2 voltage-fed open contact
Relay contacts:	max. 6A 250V AC
Operating temperature:	0 ... 50° C
Type of protection:	IP 54

## 1.4 Accessoires

Label	Denomination	Type	Manufacteur	Supplier	RNA-Mat-code
XS1	Connector		Harting		
XS3	Coupler connector, 5-poles, straight	09 0113 70 05	Binder	EVG	35051144
XS3	Coupler connector, 5-poles, angular	99 0113 75 05	Binder	EVG	35002546
XS4	Coupler connector, 7-poles, straight	09 0126 70 07	Binder	EVG	35051153
XS4	Coupler connector, 7-poles, angular	99 0126 75 07	Binder	EVG	35002545

## 2 Safety Instructions

It is always necessary to read and understand the safety instructions. This ensures that valuable material is not damaged and injuries are avoided.

Steps must be taken to ensure that all persons working with this control unit are familiar with the safety regulations and observe them.

The device described in this manual is a control unit for operating RNA bowl feeders and linear feeders. The limit values specified in the technical data must be observed.



### Note!

This hand indicates tips on operation of the control unit.



### Attention!

This warning triangle indicates safety instructions. Failure to heed this warning can lead to severe injuries or death!

Work on electrical equipment of the machine/plant may be carried out only by a trained electrician or by untrained persons under the leadership and supervision of a trained electrician in accordance with the regulations for electrical engineering!



All safety and danger signs on the machine/plant must be observed!

The electrical equipment of a machine/plant must be inspected and checked regularly. Defects such as loose connections or damaged cables must be remedied immediately!



Before commencing operation, make sure that the earthing line (power earth, PE) is intact and installed at the connecting point. Only test instruments approved for this purpose may be used for checking the safety grounding conductor.

## 3 Commissioning Instructions

Before connecting up to the mains and switching on the control unit, it is essential to check the following points:

- Is the control unit in proper working condition and closed with all screws?
- Are the connector locks clicked in/screwed secure?
- Are all cables and glands intact?
- Is PROPER INTENDED USAGE ensured?
- Does the mains voltage specification on the control unit agree with the local mains voltage?
- Does the mains frequency specification on the vibratory drive agree with the local mains?
- Is the correct operating mode set on the control unit? (See "Operating Mode" section)



Operation of the control unit may be commenced only when all questions asked above can be answered unambiguously with YES.

Before you start operation after repair work has been carried out or control units/vibrating drives have been exchanged, set the output on the control unit to minimum before switching on. Check that the system is working properly when you increase the output.



Before opening the control unit you have to wait approx 5 min after disconnecting from the main., so that the charge can be unloaded to a safe voltage.



### 3.1 OPERATING MODE

To avoid mechanical and/or electrical damage occurring to the ESR 2000 control or connected equipment, the parameters listed in the tables below must be strictly adhered to. If you cannot find your particular type of drive unit listed in the tables then contact RNA AUTOMATION for advice.

To make shure that the drive unit will run smooth and stabel, it is necessary to use use a good balanced bowl.

Please refer also to the manuals of the drive units, to see how the springs have to be adjusted.



**Table 1**

Bowl Feeder Type of Drive	max. current [A <sub>eff</sub> ]	max. magnet gap [mm]	Frequency range	Colour of Magnet
SRC - N 160 - 2	0,6	0,5	90...120 Hz	Black
SRC - N 200 - 2	1,2	0,5	90...120 Hz	black
SRC - B 200 - 2	1,2	0,5	90...120 Hz	black
SRC - N 250 - 2	2,6	1,2	90...120 Hz	black
SRC - B 250 - 2	2,8	1,2	90...120 Hz	black
SRC - N 400 - 1	3,8	2,8	45...60 Hz	red
SRC - N 400 - 2	4,3	1,2	90...120 Hz	black
SRHL 400 - 1	5,7	2,8	45...60 Hz	red
SRHL 400 - 2	5,3	1,5	90...120 Hz	black
SRC - N 630 - 1	5	2,8	45...60 Hz	red

**Table 2**

Linear Feeder Type of Drive	max. current [A <sub>eff</sub> ]	max. magnet gap [mm]	Frequency range	Colour of Magnet
SLL 175	0,07	0,8	90...120 Hz	black
SLL 400	0,6	1	90...120 Hz	black
SLL 800	1,4	3	45...60 Hz	red
SLL 804 <1600	1,4	3	45...60 Hz	red
SLL 804 ≥1600	2,8	3	45...60 Hz	red
SLF 1000	2,6	2,5	45...60 Hz	red
SLF 1500			45...60 Hz	red
GL 01	0,6	1,0	90...120 Hz	black
GL 1	1,1	1,2	90...120 Hz	black
SLK - N 6	1,4	2,5	45...60 Hz	red
SLK - N 6 G	1,4	2,5	45...60 Hz	red

For easy differentiation (recognition of frequency ranges) RNA magnet cables are colour coded as follows:

Cable Colour	Netfrequency	Variable Frequency
Black	50/(60) Hz	45...60 Hz
Grey	100/(120) Hz	90...120 Hz

**WARNING:**

To avoid serious mechanical damage to the feeder unit, the maximum magnet gap and maximum current level MUST NOT be exceeded.

**3.1.1 First Running**

RNA can supply an adapter for running with easy plug-in between controller and drive unit. The adapter included a measuring unit for load current and coil voltage with a disconnecting switch. Type ESZ 01

**Please note that all parameters of the controller are tuned up to the bowl feeder if supplied as a package with an ESR 2000 unit and in parameter 143 User 0.3 stored. All settings are stored and retrievable.**



Reconfigurations, exchange of controllers or mechanical alterations may cause damages to springs, vibrating plate, tooling or transfer devices, when putting the feeder improperly into operation

### 3.1.2 Initial Set Up

#### Procedure:

1. Check the feeder type against the ones shown in Table 1 and 2 for correct magnet gap settings, correct current settings and the frequency range.
2. Connect the ESR2000 control without feeder to the mains supply and switch on.
3. **Do not connect the feeder unit to the ESR2000 at this stage.**

#### 4. Select Code 001:

Select code

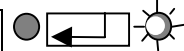
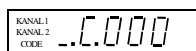

Set code



Code C001

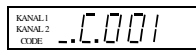

#### 4. Set Amplitude to 50 % :

Set Amplitude

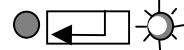
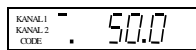

0 - 100 %



#### 5. Set the frequency. Refer to table 1 or 2 for the drive unit

Frequency

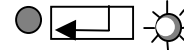
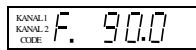

45 - 120



#### 6. Save settings:

Return

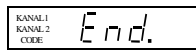

Store and return to main menu

#### 7. Switch off the controller

#### 8. Connect the feeder to the controller

#### 9. Switch on the controller



**The drive unit must run now!**

#### 10. Select again Code 001

Select code

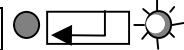
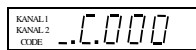

Set code



Code C001



#### 11. Set Amplitude to 90 % :

Set Amplitude

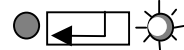
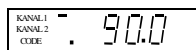

0 - 100 %



#### 12. Reduce the frequency until the correct speed and vibration is achieved.

Operating Frequency

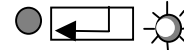
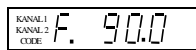

45 - 120



#### 13. Check the current load is below the maximum level indicated in Table 1 and 2!

For easy running and to determine the load current, RNA can supply a plug adapter ESZ 01

#### 14. Save your settings

Return

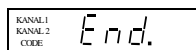

Store and return to main menu

With Code C210 you can reset to factory settings or restoring the stored user parameters



Failure to heed above mentioned warnings can lead to destroy the feeding equipment or parts thereof. In this case all warranty claims cease to exist.

After the first adjustment is successful, you can set the sensor inputs and the soft run or stopping time.

### 3.2 Sensor Inputs and Sensor Links

The control unit has two built-in sensor inputs. They can be used for checking the back pressure, the level, for cycle control and other monitoring functions. The following basic rules apply:

Sensor input 1 acts on channel 1, in case nothing else has been programmed in menu C006. Sensor input 2 has been provided for additional functions. See sensor links. The sensor inputs can only be evaluated when they are activated. See the connecting diagram for the sensor connections (XS3 plug connection).

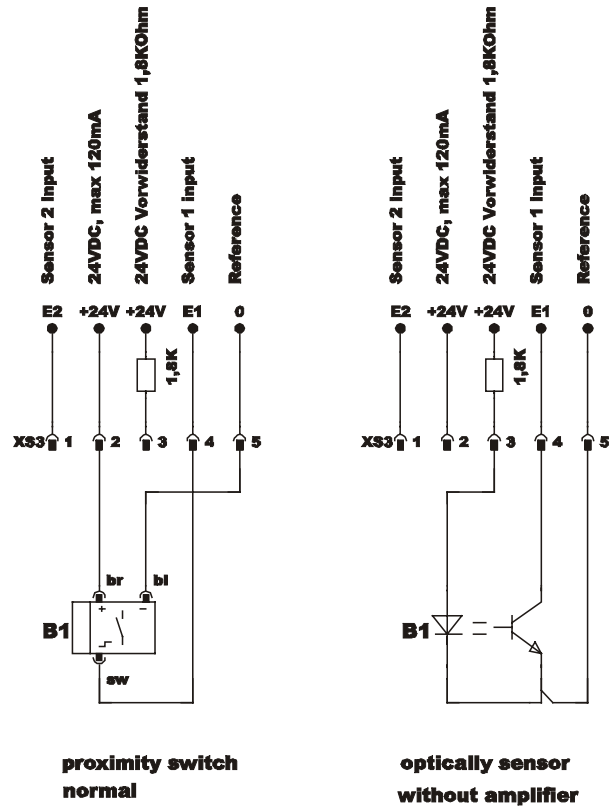
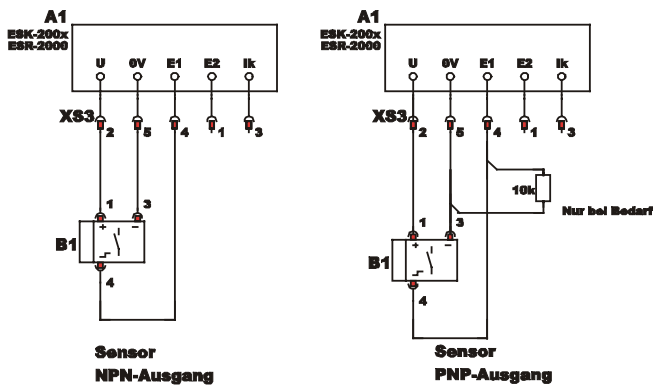
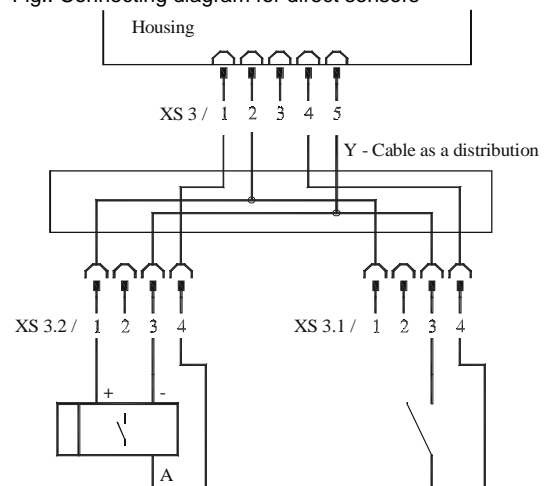
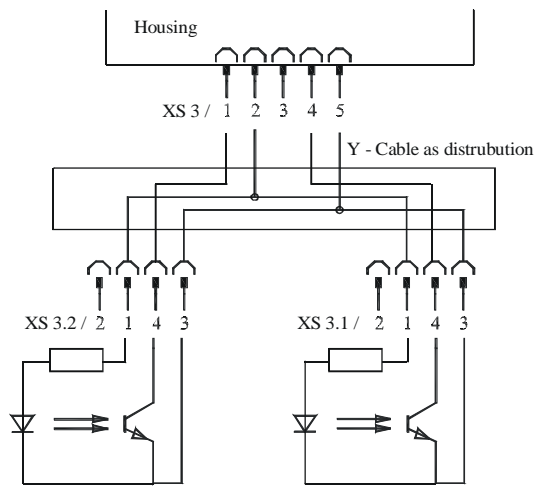

Fig.: Connecting diagram for direct sensors



Termination of a sensor and a contact by adapter.

Fig.: Connecting diagram for sensors on 2-way distributor



Amplifierless photocell with external preresistor 1.8 kOhms, 0.25W resistor soldered into plug.

Fig.: Connecting diagram for photocell without amplifier on the 2-way distributor

control units together. They are unassigned NPN-doped transistor routes and are potential-free.

The transistor route is always connected at the **STANDBY** status output when the control unit is connected to the mains and switched on with the mains power switch.

The **ON ACTION** status output requires the same conditions as **STANDBY**. Channel 1 must also be active as the transistor will block if it is set to **BACK PRESSURE**, **OFF** or **STOP**. The status outlet and the remote control should be wired via the **XS4** plug connection.

The two relays have different functions. **K1** works as a status relay parallel to the **ON ACTION** back pressure output. **K2** is either used for the delayed switch-off of blow-off air or for a cycle control function for one of the two sensor channels.

The connections and the cable inlets are on the right-hand side of the control unit. The terminal strip is behind the control unit panel.

### 3.3 Status Outputs and Relays

The status outputs are used for remote diagnostics of the control unit operating mode or for linking several

## 4. Operation





### 4.1 General



## Control unit plug connections

<u>Mains power switch</u>	The control unit is isolated from the mains with a double-pole switch.
<u>XS 3</u>	Plug connector for sensors
<u>Channel 1</u>	Plug connector for bowl feeder or linear feeder (< 10A)
<u>XS 4</u>	Plug connector for optocoupler outputs and remote control input

## The control unit display (membrane keyboard)

	<b>On/off</b> This key switches all connected devices off. "OFF" will appear in the display. The control unit is still ready for operation.
	<b>Cursor up and cursor down</b> Use these keys to page through the control unit menu or to set parameters.
	<b>Enter</b> Use this key to confirm the parameters entered with the cursor.
	<b>Decimal point in display</b> If the decimal point is not flashing, you cannot make an entry.
	If the decimal point is flashing, you can make an entry.

## 4.2 Switching on the Control Unit

Switch on the control unit with the mains power switch. The main menu will appear in the display showing the last setpoint set in channel 1 (Bowl feeder or linear feeder feed rate).

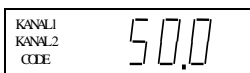

The following displays may also appear depending on the circuit state of the unit.

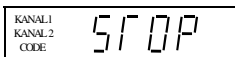

The remote control has been activated but is currently not available on the unit.

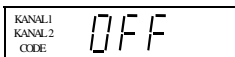

The unit has been switched off with the upper left-hand key on the membrane keyboard, all functions are blocked.

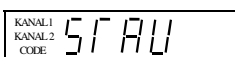

The back pressure monitoring sensor has been assigned thus switching off channel 1 (Bowl feeder).

## 4.3 Main Menu/Setting and Displaying Setpoints for Channel 1

Display of setpoint or the channel 1 output (Bowl feeder)  
Alternatively: STOP, OFF or BACK PRESSURE  
(see above)

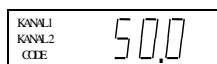

No entries possible

Enter code to change or make required settings.

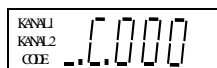

Enter code.  
See section 4.4 for description of code.



Setpoint preset  
(Bowl feeder or linear feeder)

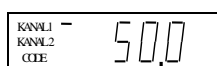

Entry in %; return to display mode to store





From these three basic displays you can page through the main menu using the cursor keys (UP/DOWN). Press the ENTER key in the main menu to activate a menu item for setting or adjustment. The decimal point will flash once you have pressed the ENTER key. Changes can now be made using the cursor keys (UP/DOWN). Confirm the entries by pressing the ENTER key again. The decimal point will no longer flash. You can scroll further through the menu using the cursor keys. This procedure is also used in the code menus described below.

All displays shown in the following section represent the factory settings. If the actual display on the control unit differs, the factory setting has been changed in the individual codes for a specific application.

## 4.4 Description of the Individual Codes for Programming the Control Unit

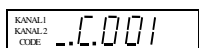

### Settings for channel 1

The following functions can be set or limited for channel 1 in this submenu:

- vibration amplitude
- signal direction of the remote control
- remote control
- soft start time and soft stop time



### Lock setpoint

This submenu allows the setpoints (oscillation amplitude) to be blocked in the main menu. The setpoints for channel 1 can no longer be changed in the main menu. This prevents the output values being accidentally changed. Changes can only be made using code C001.



### Setting sensor input 1

Sensor input 1 is activated in this submenu. The following functions can also be set.

- invert input signal direction
- time before switch-on
- time before switch-off



### Setting sensor input 2

Sensor input 2 is activated in this submenu. The following functions can also be set.

- invert input signal direction
- time before switch-on
- time before switch-off

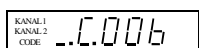

### Selecting the sensor links

The sensors activated with codes C004 and C005 can be linked to each other in this submenu.

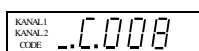

### Setting the cycle control system

Set the sensor input to be monitored and how the control will react when there is a fault.

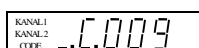

### Display status

This submenu is used to check the set vibration frequency and the sensor inputs and reset of error signals



### Programmed application examples

Call memorized settings P1-10 based on application examples.

(ask for our catalogue fax 0241/5109-219 or by Internet [www.rna.de](http://www.rna.de))

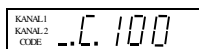

### Output preset with an external voltage. 0-10V or potentiometer

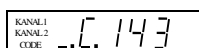

### Store parameters

If the values (user parameters) previously set in the different submenus are to be stored, call this submenu.

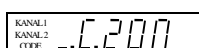

### Block all setting functions

This code blocks all entry options on the control unit. The values can no longer be changed. The menu can now only be enabled using this code.

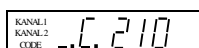

### Reset parameters

This submenu allows the user to reset the control unit to the factory settings. If user parameters have been stored, the control unit can also be set to these settings.

## 4.5 Application-specific Changes to the Factory Settings

### 4.5.1 Code C001 for power output

**Aim:** Setting and limiting the vibration amplitude, the remote control, the soft start time and the soft stop time.

<b>Select code</b>			<b>Set code</b>	
<b>Code C001</b>				
<b>Set vibration amplitude</b>			<b>0 - 100 %</b>	
<b>Limit vibration amplitude</b> For RNA-Feeder with 100V/200 V Magnets 90%			<b>50 - 100 % (*)</b>	
<b>Remote control</b>			<b>1 = active</b> <b>0 = inactive</b>	
<b>Remote control signal direction</b>			<b>1 = start = 24V DC</b> <b>0 = stop = 24V DC</b>	
<b>Soft start time</b>			<b>0 - 5 sec.</b>	
<b>Soft stop time</b>			<b>0 - 5 sec.</b>	
<b>Operating Frequency</b> (see 3.1 Operating Mode)			<b>35 - 140</b>	
<b>Return</b>			<b>Store and return to main menu</b>	

### 4.5.2 Code C003 Lock Setpoint

**Aim:** Blocking the setpoints in the main menu. The values can no longer be changed directly. Changes can only be made using code C001.

<b>Select code</b>			<b>Set code</b>	
<b>Code C003</b>				
<b>Setpoint (vibration amplitude)</b>			<b>1 = can be set</b> <b>0 = entry blocked</b>	
<b>Return</b>			<b>Store and return to main menu</b>	

### 4.5.3 Code C004 Sensor Input 1 and Code C005 Sensor Input 2

**Aim:** Activating and setting the sensor inputs

<b>Select code</b>			<b>Set code</b>	
<b>Code C004</b>				
<b>Sensor 1 input</b>			<b>1 = active</b> <b>0 = inactive</b>	
<b>Invert input signal direction</b>			<b>1 = start = 24V DC</b> <b>0 = stop = 24V DC</b>	
<b>Sensor state delay</b> <b>FREE, time before switch on.</b>			<b>0 - 60 sec.</b>	
<b>Sensor state delay</b> <b>ASSIGNED, time before switch-off.</b>			<b>0 - 60 sec.</b>	
<b>Return</b>			<b>Store and return to main menu</b>	

 Code **C005** is used for sensor input 2 in the same way.

## 4.5.4 Code C006 Sensor Links

**Aim:** Linking two previously activated sensor inputs.

Select code



Code C006

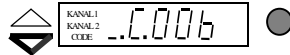

 Only one of the eight sensor links can be set active.

**And (And) link with blow-off of the outlet tracks**

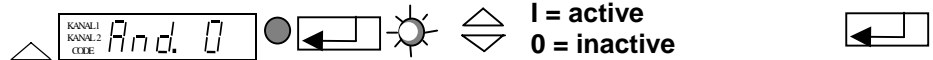

**And (und) link without blow-off of the outlet tracks** (since Versions-No. 10)

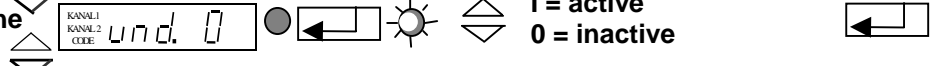

**Or link**

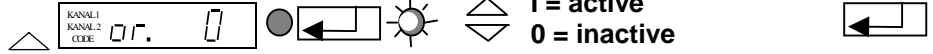

**Min/Max link**



**And / S2 link** (since Versions-No. 10)

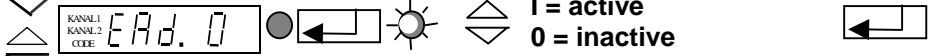

**Level control for the hopper controller** (since Versions-Nr. 10)

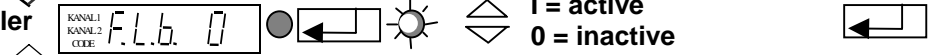

**Level control**



**Single link**

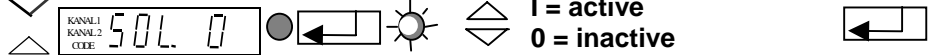

**Return**



Store and return to the main menu

### A brief description of the individual links

 **And (AND) link** of the two sensor inputs with blow-off of the outlet tracks.  
Example:

**Application:** Two-track feeding system with back pressure control

**Solution:** Track 1 (Sensor 1) full = blow-off track 1 (Relais K1)

Track 2 still free

Track 2 (Sensor 2) full = blow-off track 2 (Relais K2)

Track 1 still free

Track 1 + Track 2 full = bowl feeder (chanal 1) stop blow-off air after approx. 4 sec

 **And (UND) link** of the two sensor inputs without blow-off of the outlet track.

The bowl feeder (chanal 1) switches off, if both sensors are assigned. The air for sorting may be de-energizes later (4 sec) through relay K2.

 **Or link** of both sensor inputs.

The bowl feeder switches off (chanal1), if one of both sensors is assigned. The air for sorting may be de-energizes later (4 sec) through relay K2.

 **Min/Max link** of both sensor inputs.

The bowl feeder (chanal 1) switches off, if both sensors are assigned. Only when both sensors become free, the bowl feeder (chanal 1) switches on again. Relay K1 connects, with the switch off of the bowl feeder. Relay K2 connects 4 sec later (to switch off the blow-off air)

 **And / S2 link**

The bowl feeder (chanal 1) switches off, when both sensors are assigned. When the sensor 2 is free, the system is switched on. The air for sorting can be switched off later (4sec) through relay K2.

 **Level control for the hopper**

Sensor 2 switches relay K1 according to the entered delay time (C005). When the sensor 1 is darkened, relay K1 releases (looking of the hopper).

**Application:** Sensor 1 = traffic sensor ; Sensor 2 = level control ; Relay K1 = control hopper

 **Level control**

Sensor 2 switches relay K1 according to the entered delay time (C005).

Application: Sensor 2 will be used as a level control (z.B. LC-N 24V DC). Relais K1 switches with a level controller: *Bowl feeder or linear feeder empty.*

### 4.5.5 Code C008 Cycle Control

Aim: Control sensors 1 (back pressure control) and/or 2.

The links "AND, SOL" must not be activated in code C006 when the cycle control system is activated.

Select code			Set code	
Code C008				
Sensor input 1 is monitored			I = active 0 = inactive	
Sensor input 2 is monitored			I = active 0 = inactive	
Monitoring dependent on channel 1			I = active 0 = inactive	
Time until alarm signal			3 - 240 sec.	
Switch off channel 1			I = see below 0 = see below	
Switch (Relay K1)			I = warning at relay K1 0 = warning at relay K2	
Return			Store and return to main menu	

The cycle control system monitors the FREE sensor state. The time (A 180) is used to set the maximum time which a sensor may be free before an alarm signal is issued. Relay K1 is picked up when an alarm signal is issued. The fault is cleared by covering the sensor.

If OUT = 1 and a fault occurs, the bowl feeder or linear feeder will also be switched off in addition to relay K1 (indicator lamp: fault) and an ERROR message will appear in the display. The fault is cleared with the cursor key at the bottom right. If OUT = 0 and a fault occurs, only relay K1 is energized (indicator lamp: fault). The fault is cleared automatically when sensor 1 is assigned.

If A.I. = 1 Relay K1 is checked on breakdown (switch changed over from relay K2 to K1)

### 4.5.6 Code C009 Display Status/Return ERROR - signals

Aim: Checking the set vibration frequency and the sensor inputs.

Select code			Set code	
Code C009 Clear error				
Remote control signal channel 1			I = active 0 = inactive	
Signal at sensor input 1			I = active 0 = inactive	
Signal at sensor input 2			I = active 0 = inactive	
Return			Store and return to main menu	

With the menu item HA = half-wave you can check whether the operating mode (100–50Hz) has been correctly selected.

## 4.5.7 Code C200 Blocking all Setting Functions

**Aim:** The user can no longer (accidentally) change the set values.(4.3 available)

Select code			Select code	
Code C200				
Block the setting functions			I = enabled 0 = block	
Return			Store and return to main menu	

**Now only code C200 will be accepted!!!**  
It is possible to change the setpoint for channel 1 and 2 in the main menu (see 4.3)

## 4.5.8 Code C100 Output Preset with an External Voltage

**Aim:** Setpoint adjustment with external voltage

Select code			Select code	
Code C100				
External supply channel 1			I = active 0 = inactive	
Return			Store and return to main menu	

If the external supply is activated, the last set digital output value (%) will be the minimum output for 0 volt. The maximum output for 10 volts should be set with the parameter P in C001.

The external voltage supply should be connected to terminal 31, 32 and 33 in the control unit. The connection is potential-free.  
Terminal 31 = +10V  
Terminal 32 = E  
Terminal 33 = 0V

## 4.5.9 Code C143 Store Parameters

**Aim:** Storing user parameters.

Select code			Select code	
Code C143				
Selection memory space 0-3				
Store				
Return			Store and return to main menu	

Once PUSH has been confirmed with ENTER, the selected parameters will be stored separately by pressing a cursor key.

## 4.5.10 Code C210 Reset Parameters

**Aim:** Resetting to factory settings or restoring the stored user parameters.

Select code



Set code



Code C210

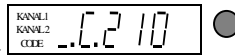

Factory setting

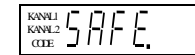
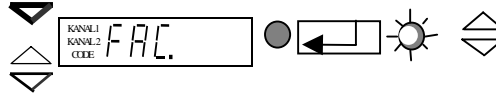

User parameters

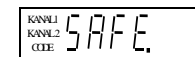
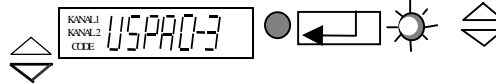

Return

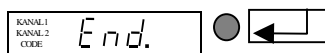

Store and return to main menu

 **FAC** Selection and confirmation of **FAC**. applies the factory settings.

 **US.PA** Selection and confirmation of **US.PA** restores the user parameters previously stored under C143.

## 4.5.11 Failure

In case of failure, the controller shut-off automatically showing a flashing „ERROR“ text. The error signal is stored even on disconnecting the line up to the moment when the error indication is cleared in C009.

**Overload limiting ERROR**

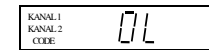
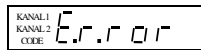

The output power is beyond allowable limit

**Short circuit break**

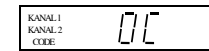
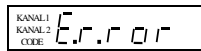

A short circuit occurs when in operation

**Overvoltage circuit break**

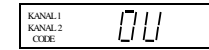
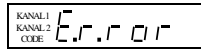

Voltage is or was too high

**Peak current limiting**

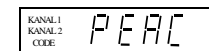
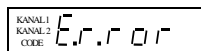

An excessive peak current occurred





D

**Rhein-Nadel Automation GmbH**

Reichsweg 19/42 • D - 52068 Aachen  
Tel (+49) 0241/5109-159 • Fax (+49) 0241/5109-219  
Internet [www.rna.de](http://www.rna.de) • Email [vertrieb@rna.de](mailto:vertrieb@rna.de)

**Rhein-Nadel Automation GmbH**

Zweigbetrieb Lüdenscheid  
Nottebohmstraße 57 • D - 58511 Lüdenscheid  
Tel (+49) 02351/41744 • Fax (+49) 02351/45582  
Email [werk.luedenscheid@rna.de](mailto:werk.luedenscheid@rna.de)

**Rhein-Nadel Automation GmbH**

Zweigbetrieb Ergolding  
Ahornstraße 122 • D - 84030 Ergolding  
Tel (+49) 0871/72812 • Fax (+49) 0871/77131  
Email [werk.ergolding@rna.de](mailto:werk.ergolding@rna.de)

CH

**HSH Handling Systems AG**

Wangenstr. 96 • CH - 3360 Herzogenbuchsee  
Tel (+41) 062/95610-00 • Fax (+41) 062/95610-10  
Internet [www.rna.de](http://www.rna.de) • Email [info@handling-systems.ch](mailto:info@handling-systems.ch)

GB

**RNA AUTOMATION LTD**

Hayward Industrial Park  
Tameside Drive, Castle Bromwich  
GB - Birmingham, B 35 7 AG  
Tel (+44) 0121/749-2566 • Fax (+44) 0121/749-6217  
Internet [www.rna-uk.com](http://www.rna-uk.com) • Email [rna@rna-uk.com](mailto:rna@rna-uk.com)

E

**Vibrant S.A.**

Pol. Ind. Famades C/Energia Parc 27  
E - 08940 Cornellà Llobregat (Barcelona)  
Tel (+34) 093/377-7300 • Fax (+34) 093/377-6752  
Internet [www.vibrant-rna.com](http://www.vibrant-rna.com) • Email [info@vibrant-rna.com](mailto:info@vibrant-rna.com)

CAN

**RNA Automated Systems Inc.**

1349 Sandhill Drive Unit 101  
Ancaster, Ontario  
Canada, L9G 4V5  
Tel (+1) 905/3049950 • Fax (+1) 905/3049951  
Mobil (+1) 905/9756562  
Email [sales@rna-can.com](mailto:sales@rna-can.com)  
[www.rna-can.com](http://www.rna-can.com)

VT-BA-ESR2000-GB

05.07.06